

Sales Code: ARV803

Description: Arvan D/M Bath Filler

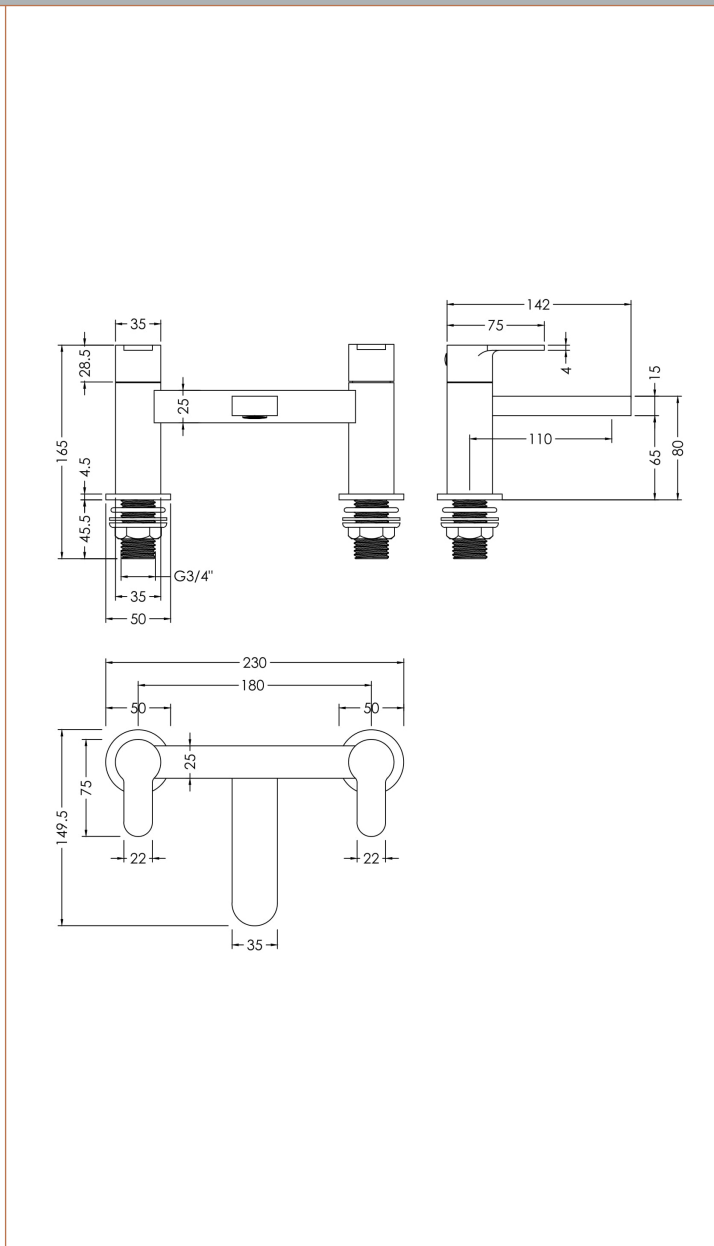

Product Dimensions	
Height (mm):	120
Width (mm):	230
Depth (mm):	142
Length (mm):	
Nett Weight (kg):	1.77
Packaging Dimensions	
Height (mm):	205
Width (mm):	190
Depth (mm):	270
Gross Weight (kg):	1.77
Packaging Data	
Box Colour:	White Cardboard Box
Box Qty:	0
Label Size:	0 x 0
Label Colour:	White Label
Label Qty:	0
Outer Box Dimensions (If Applicable)	
Height (mm):	560
Width (mm):	540
Depth (mm):	530
Length (mm):	
Gross Weight (kg):	
Barcode:	5056462601304
Product Details	
Country of Origin:	China
Fitting Instruction:	No
Product Material:	Brass
Control Type:	Manual
Waste Included:	Waste Not Included
Waste Type:	Not Applicable
WRAS Approval: Yes	Approval No: 2206032
Valve/Cartridge Type:	1/4 Turn Ceramic Disc
Colour/Finish:	Brushed Brass
Mount Type:	Deck
Operating Pressure (bar):	1
Flow Rates: (Litres Per Min)	0.1 bar: 6 0.5 bar: 16.1 1 bar: 23.3 2 bar: 3.3 3 bar: 41.1
Pipe Size:	3/4"
Pipe Centres:	180