

Sales Code: HDY303

Description: Hardy Bath Filler

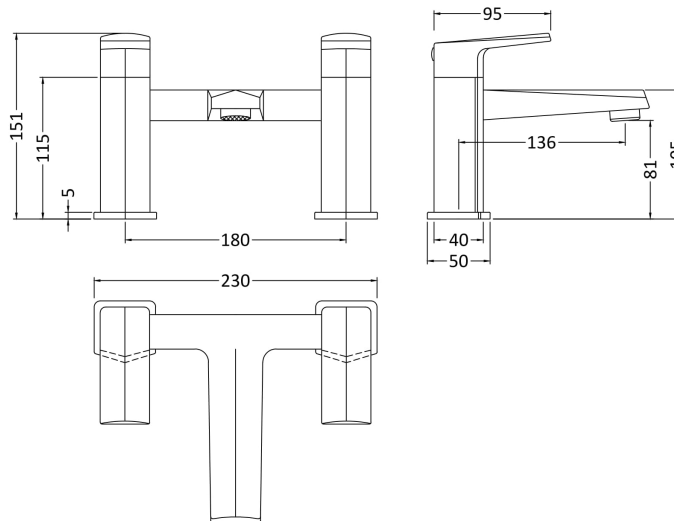

Product Dimensions

Height (mm):	151
Width (mm):	230
Depth (mm):	175
Length (mm):	
Nett Weight (kg):	2.39

Packaging Dimensions

Height (mm):	170
Width (mm):	240
Depth (mm):	225
Gross Weight (kg):	2.39

Packaging Data

Box Colour:	White Cardboard Box
Box Qty:	0
Label Size:	0 x 0
Label Colour:	White Label
Label Qty:	0

Outer Box Dimensions (If Applicable)

Height (mm):	185
Width (mm):	260
Depth (mm):	180
Length (mm):	
Gross Weight (kg):	
Barcode:	5055275883020

Product Details

Country of Origin:	China
Fitting Instruction:	Yes
Product Material:	Brass
Control Type:	Manual
Waste Included:	Waste Not Included
Waste Type:	Not Applicable
WRAS Approval: No	Approval No: N/A
Valve/Cartridge Type:	1/4 Turn Ceramic Disc
Colour/Finish:	Chrome
Mount Type:	Deck
Operating Pressure (bar):	0.1

Flow Rates: (Litres Per Min)	0.1 bar: 4.9	0.5 bar: 11.8	1 bar: 17.1	2 bar: 24.2	3 bar: 29.8
Pipe Size:	22 mm (3/4" Bsp)				
Pipe Centres:	180 mm				