

Sales Code: BIN333

Description: Binsey D/M 3Th Bath Filler

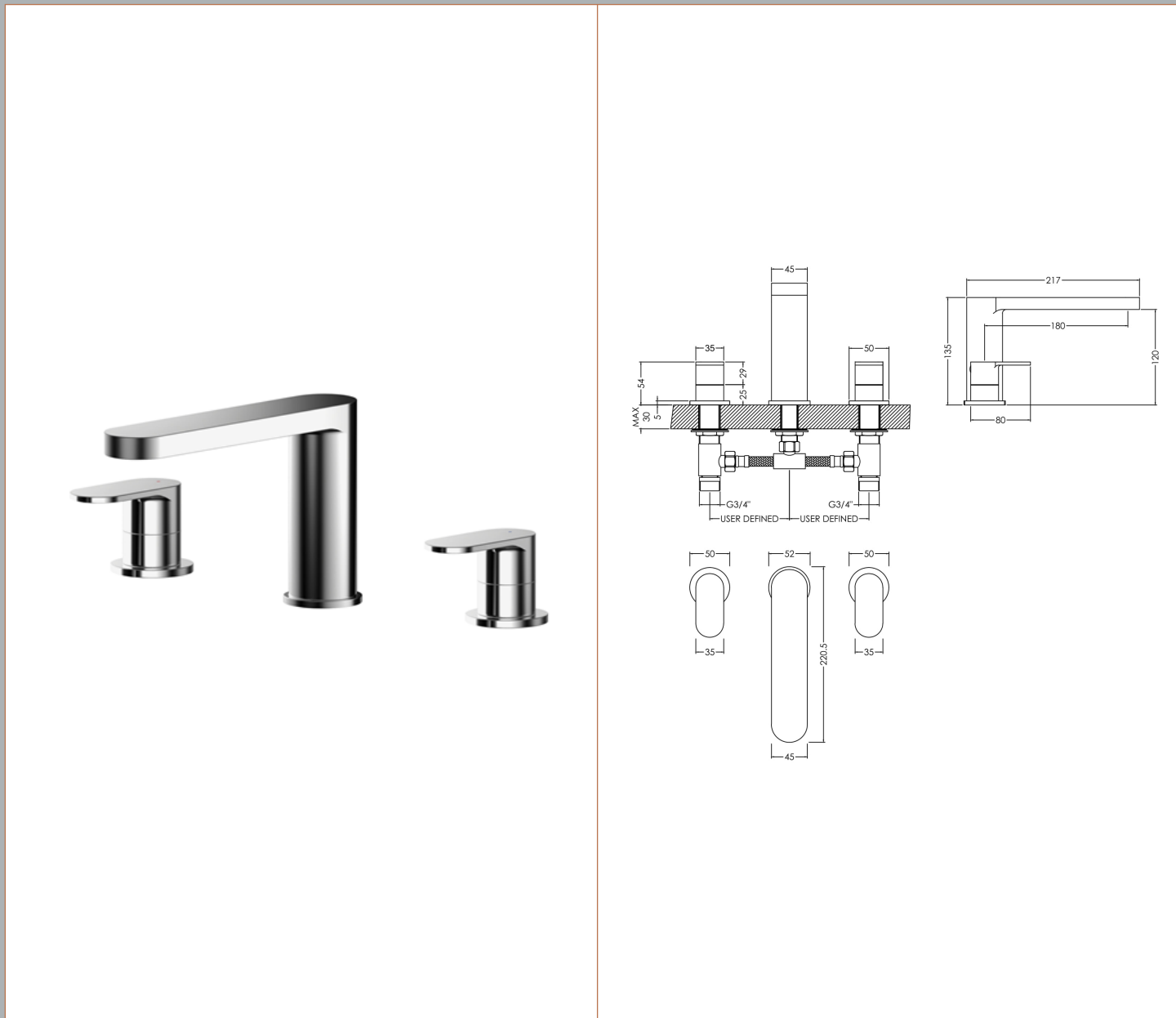

### Product Dimensions

Height (mm):	135
Width (mm):	245
Depth (mm):	217
Length (mm):	
Nett Weight (kg):	2.82

### Packaging Dimensions

Height (mm):	155
Width (mm):	235
Depth (mm):	335
Gross Weight (kg):	2.82

### Packaging Data

Box Colour:	White Cardboard Box
Box Qty:	0
Label Size:	0 x 0
Label Colour:	White Label
Label Qty:	0

### Outer Box Dimensions (If Applicable)

Height (mm):	500
Width (mm):	490
Depth (mm):	410
Length (mm):	
Gross Weight (kg):	
Barcode:	5056211898870

### Product Details

Country of Origin:	China
Fitting Instruction:	Yes
Product Material:	Brass
Control Type:	Manual
Waste Included:	Waste Not Included
Waste Type:	Not Applicable
WRAS Approval:	No
Approval No:	N/A
Valve/Cartridge Type:	1/4 Turn Ceramic Disc
Colour/Finish:	Chrome
Mount Type:	Deck
Operating Pressure (bar):	2

Flow Rates: (Litres Per Min)	0.1 bar: 3	0.5 bar: 8.8	1 bar: 13	2 bar: 18.9	3 bar: 23.1
Pipe Size:	3/4"				
Pipe Centres:	100				