

Code No.: 33.0015

Dimensions: 1500x740x610 mm

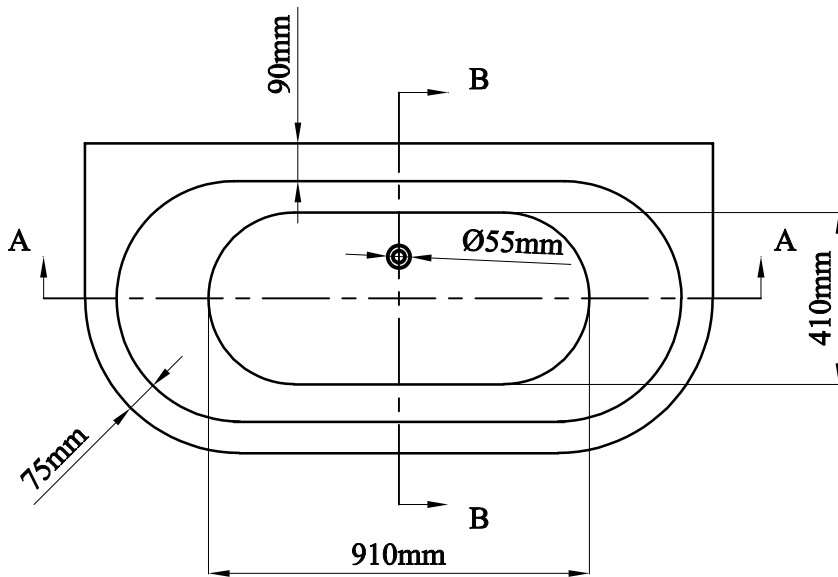
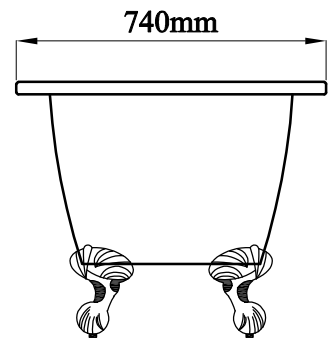
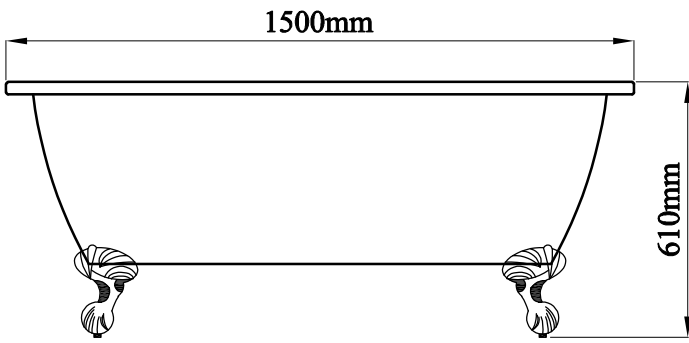

SECTION A-A

SECTION B-B

