

Code No.: 33.0018

Dimensions: 1620 x 690(600) x 760(660) mm

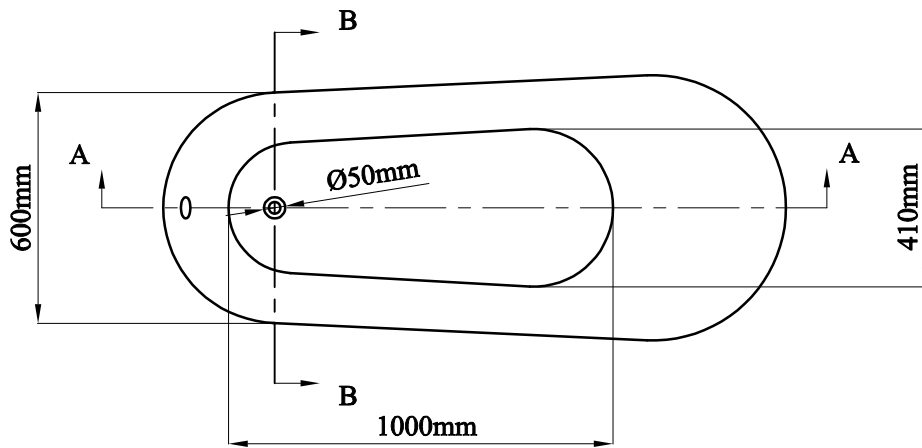
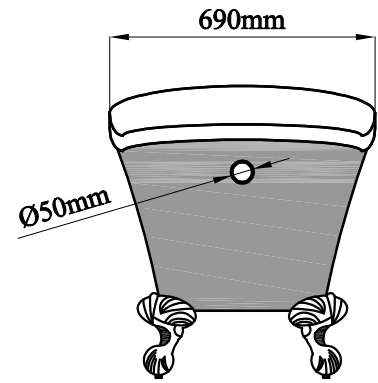
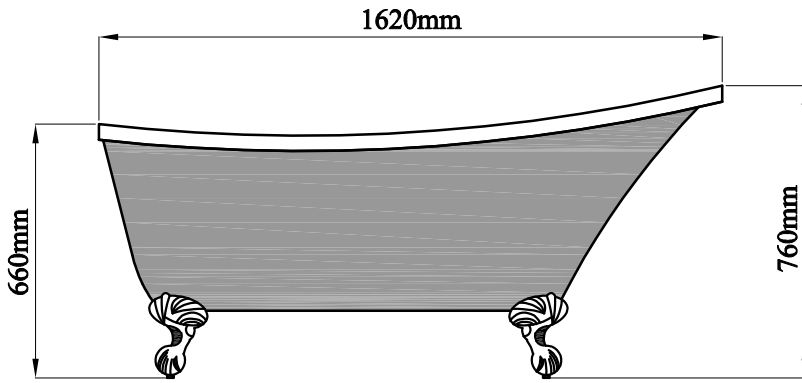

SECTION A-A

SECTION B-B

