

BRISTAN

Installation Instructions & User Guide

Please leave these instructions with the end user

Product Code: MI BAS BLK (D2)

Specifications

Dynamic Water Pressure

Min: 0.5 bar Max: 5.0 bar

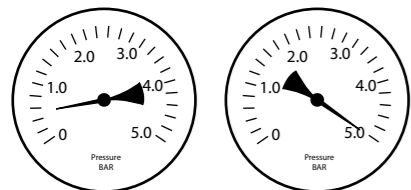

Maximum Static Pressure: 10.0 bar

Inlet Water Temperature

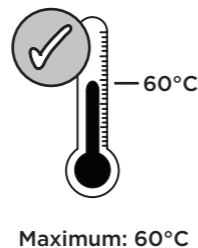

Inlet Connections

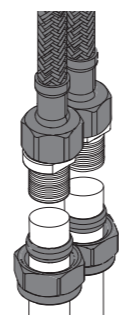

1/2" BSP Flexible Tails

* Connection adaptors not included

Tools You'll Need

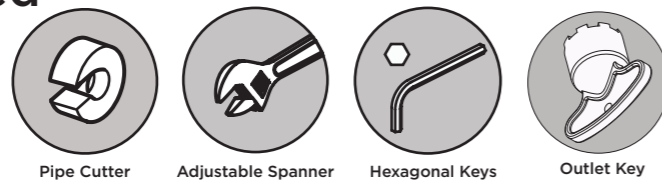

Prior to Installation

All products manufactured and supplied by Bristan are safe to use provided that they are installed, operated and receive regular maintenance in accordance with these instructions.

This product needs to be installed in accordance with, and meet the requirements of the Water Supply (Water Fittings) Regulations 1999 and current by-laws. For full Installation Requirements & Notes (IRN) please visit wras.co.uk/directory.

Isolation valves must be fitted to the inlet water supplies to ensure ease of future maintenance.

Before installing this product the water supply must be thoroughly flushed in order to remove any swarf, solder etc. Full access must be made available for future maintenance/servicing purposes.

This product must not be modified in any way as this will invalidate the guarantee.

If in doubt, contact a registered plumber, your Local Water Authority or the Secretary of the Institute of Plumbing, address as follows:-

The Institute of Plumbing,
64 Station Lane,
Hornchurch,
Essex,
RM12 6NB, Tel: 01708 472791

Pack Contents

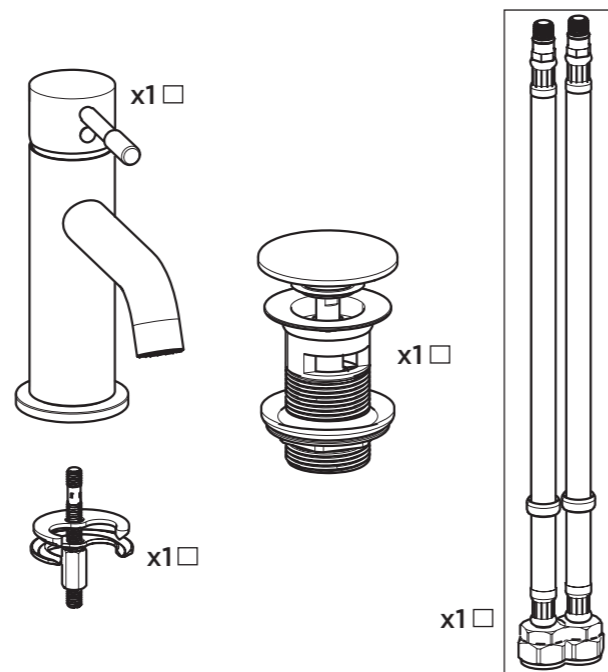

Spare Parts

To replace any spare parts for your tap, why not scan the QR Code or visit www.bristan.com and search for your product.



Installation

1

Screw in the fixing kit rods to the tap base. Screw in the flexible tails by hand only. **DO NOT OVERTIGHTEN.**

2

Fit the tap to the basin, ensuring the plinth is in place.

3

Secure the tap to the basin by using the fixing kit.

4

Connect the flexible tails to the hot and cold water supplies. We would recommend that you install tapered isolation valves to the water supplies for safety and maintenance purposes.

REMEMBER

Hot on the left, cold on the right.

IMPORTANT

Turn on water supply for a few minutes and check all joints and connections for any leaks.

Flexible Tail Positions

5

Your tap is now ready for use.

Operation

On
Hot
Cold

Waste Installation & Operation

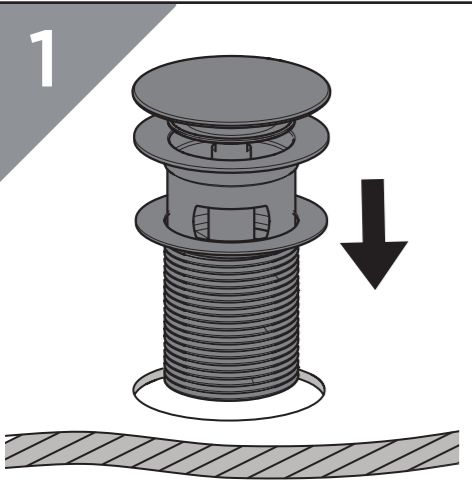
- 

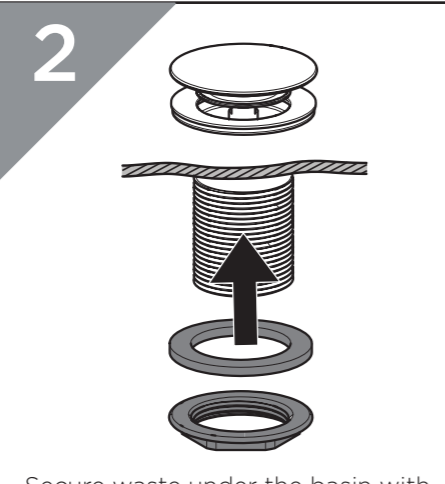
Fit the waste above the basin with the top washer.
- 

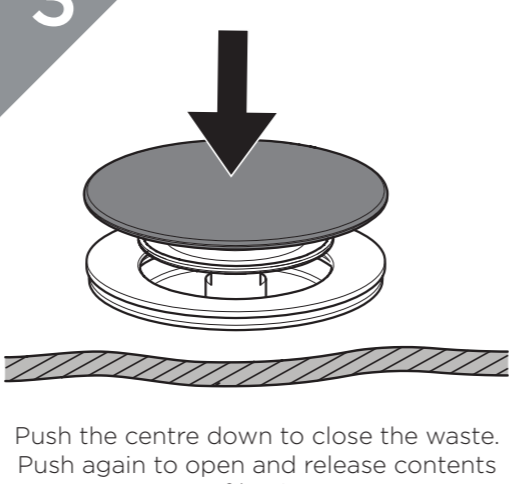
Secure waste under the basin with backnut and bottom washer
- 

Push the centre down to close the waste. Push again to open and release contents of basin.

Maintenance - Clean/Replace Outlet

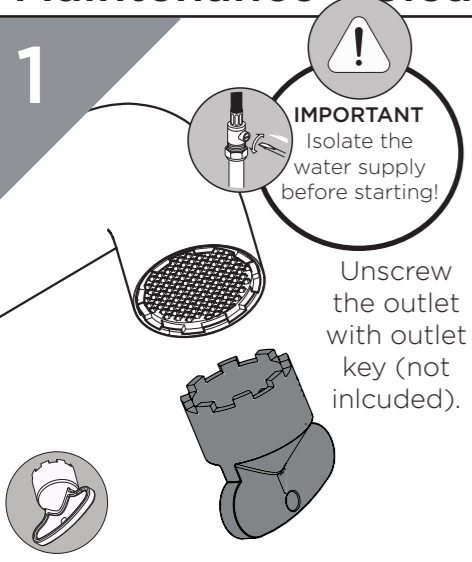
- 

IMPORTANT
Isolate the water supply before starting!

Unscrew the outlet with outlet key (not included).
- 

Place outlet parts a suitable solution and soak until fully de-scaled.
- 

Reverse the maintenance steps to replace the outlet.

Maintenance - Cartridge Cleaning

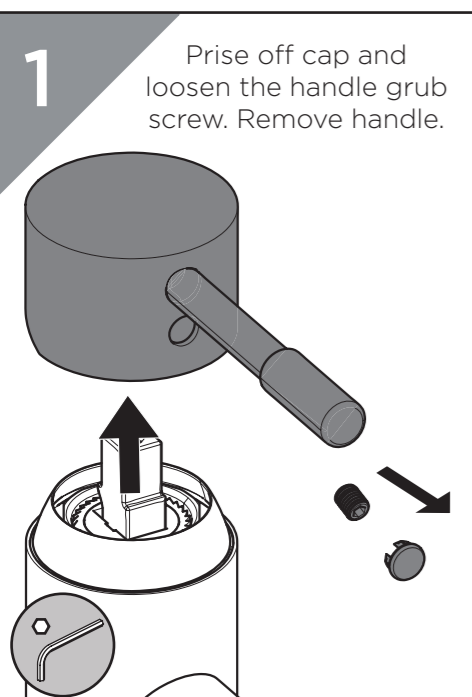
- 

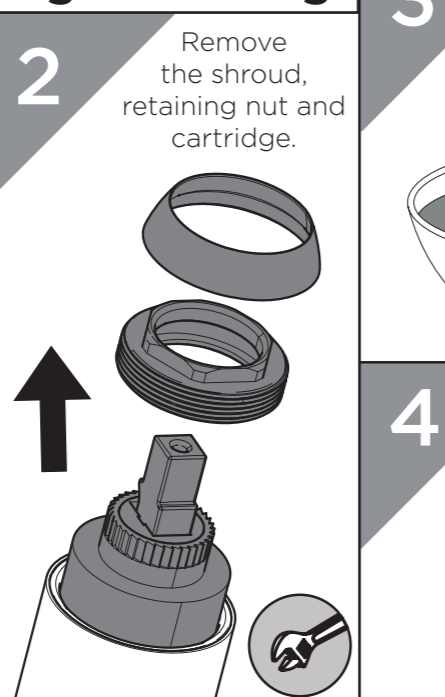
Prise off cap and loosen the handle grub screw. Remove handle.
- 

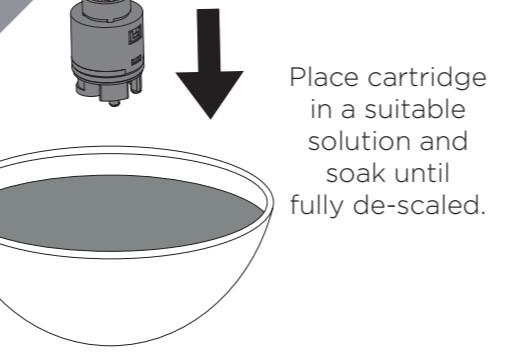
Remove the shroud, retaining nut and cartridge.
- 

Place cartridge in a suitable solution and soak until fully de-scaled.
- 

Reverse the maintenance steps to replace the handle.

Troubleshooting

Symptom	Cause	Remedy
No flow or low flow rate	Partially closed isolation valve.	Open isolation valve.
	Instantaneous water heater cycles on and off as flow rate or pressure is too low.	Increase water flow rate or pressure through system.
	Head of water is below the minimum distance required.	Refer to specification for minimum distance required.
	Hot or cold water being drawn off elsewhere causing pressure changes or instantaneous boiler temperature changes.	Do not use other water outlets when using the taps.
	Airlock or partial blockage in the supply pipework.	Flush through pipework to ensure removal of debris and any airlocks.
Water dripping from taps	This is normal for a short time after using the taps.	This is caused by residual water tension, the build up of water in the tap body.
	If water continues to drip, possibly due to the ceramic disc valves	Remove valves and clean, refer to 'Maintenance' section before starting any maintenance.
Taps do not turn on	Closed isolation valve.	Open isolation valve.
	Mains water supply turned off.	Turn on mains water supply.

General Cleaning

Bristan products are made from premium materials, with hand polishing and electroplated finishes.

Your taps or shower should be regularly cleaned with warm water, a mild pH-neutral liquid soap, and polished with a soft cloth. Any residues from soap, toothpaste, shampoos and shower gels can cause blemishes if not rinsed off straight after use.

Household bleaches and cleaners contain harsh chemicals and may damage the surface finish. Avoid using abrasive cloths, scouring pads, scrub sponges, steel wool or anything similar.

Some surfaces such as nickel and pewter may be affected by the dye found in some cloths, so it is also important to avoid hanging cloths on spouts.

Contact Us

BRISTAN

Bristan Group Ltd.

UK: Bristan Group, B78 1SG.
EU: Masco Europe S.à.r.l.
14 Rue Strachen
6933 Mensdorf
Luxembourg

Customer Service: +44330 026 6273
Web: www.bristan.com
Email: enquire@bristan.com

A Masco Company

Servicing Your Tap

We recommend servicing your tap at least once every year to prolong its life. To see a video showing how to remove the cartridge for servicing, scan the QR code with your smart phone or tablet.



Alternatively visit www.youtube.com/BristanTV

Our Guarantee

At Bristan, we want to make things as easy as possible for our customers. That's why we offer solid guarantees on all our products, effective from the date of purchase, to give you peace of mind.

To start your free guarantee simply scan the QR code and register your product. Alternatively visit www.bristan.com/register.

For any other queries, please call our Customer Service on 0330 026 6273 where our expert team of advisors will be able to offer you any help and advice.

For full guarantee terms and conditions visit www.bristan.com/service-centre/guarantees.

