

# LAGO 1

# INSTALLATION GUIDE

This product must be fitted only by a fully qualified installer.

# REINA

DESCRIPTION	ILLUSTRATION
Radiator x1	
Brackets x4	
Wall Anchors x 4	
Fixing Screws x4	
Washers x4	
Security Screws x4	

DESCRIPTION	ILLUSTRATION
Fixing choose the appropriate fixing for the wall material if required	
PTFE tape	
Electric drill	
Masonry drill bit appropriate to the fixings	
Adjustable spanner	
Radiator valve hex key	
Flat head and philips head screw drivers	
1 lock shield valve and 1 gate or thermostatic valve	
Spirit level	
Measuring tape	

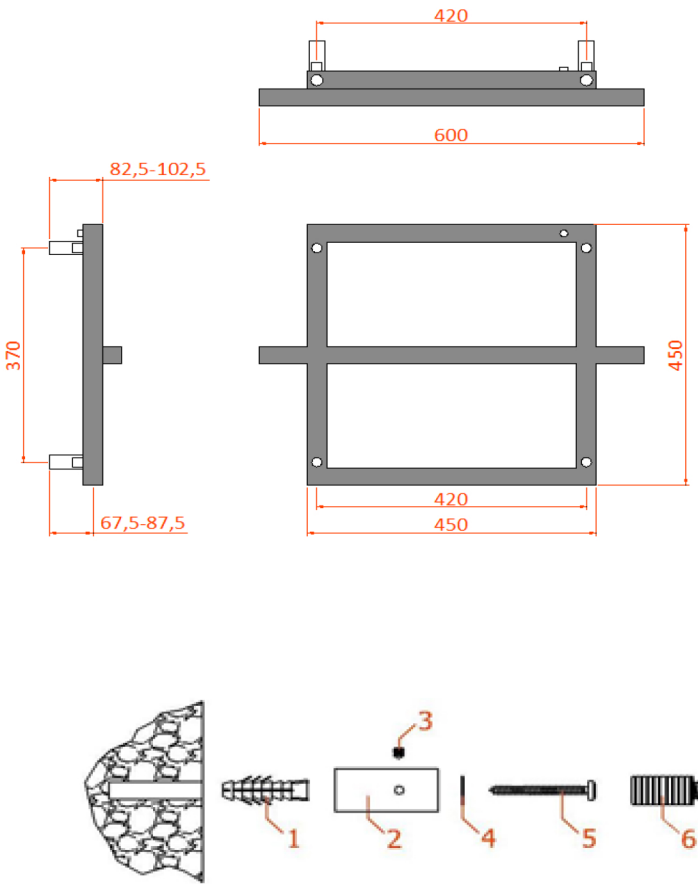

- A** The radiator should not be mounted closer than 50mm below any overhanging surface (i.e. shelf) and no lower than 100mm from the floor. Transfer the bracket drill position measurements to the wall.
- B** Drill the wall and insert wall anchors (1) (or other suitable fixings).
- C** Put the brackets (2) on the wall and screw them to the wall anchors (1) with fixing screws (5) and washers (4).
- D** Screw the brackets (6) onto the nuts welded on the back of the radiator.
- E** Insert brackets (6) into the brackets (2) and tighten the security screws (3).

### GENERAL RECOMMENDATION











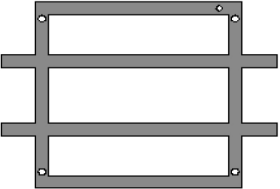



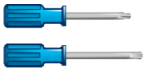

- Before fitting the radiator it is necessary to wash out the heating system to remove any existing mud, scale, work residues, traces of flux, oil, etc.
- When the system water pH is outside the 5,5-8,5 range and/or when the dissolved is above 0,1mg/litre, it is always needed to protect the heating system components (the radiator is one of these) with a proper chemical treatment compatible with all parts in contact with water (silicon rubber too).
- In order to fit the radiator to the wall, it is necessary to choose the proper fixings for the wall material.
- If the system water exceeds 50°C, please install a warning mark near the radiator to avoid any accidental scalding.
- Clean the radiator surface only with a soft cloth to avoid scratching the finish and do not use chemical agents during cleaning operations. It is prohibited to climb on the radiator.
- Maximum working temperature 95°C, maximum working pressure 4 bar.

# LAGO 2

# INSTALLATION GUIDE

REINA

This product must be fitted only by a fully qualified installer.

DESCRIPTION	ILLUSTRATION	DESCRIPTION	ILLUSTRATION
		Fixing choose the appropriate fixing for the wall material if required	
		PTFE tape	
		Electric drill	
		Masonry drill bit appropriate to the fixings	
		Adjustable spanner	
		Radiator valve hex key	
		Flat head and philips head screw drivers	
		1 lock shield valve and 1 gate or thermostatic valve	
		Spirit level	
		Measuring tape	
Radiator x1			
Brackets x4			
Wall Anchors x 4			
Fixing Screws x4			
Washers x4		Security Screws x4	

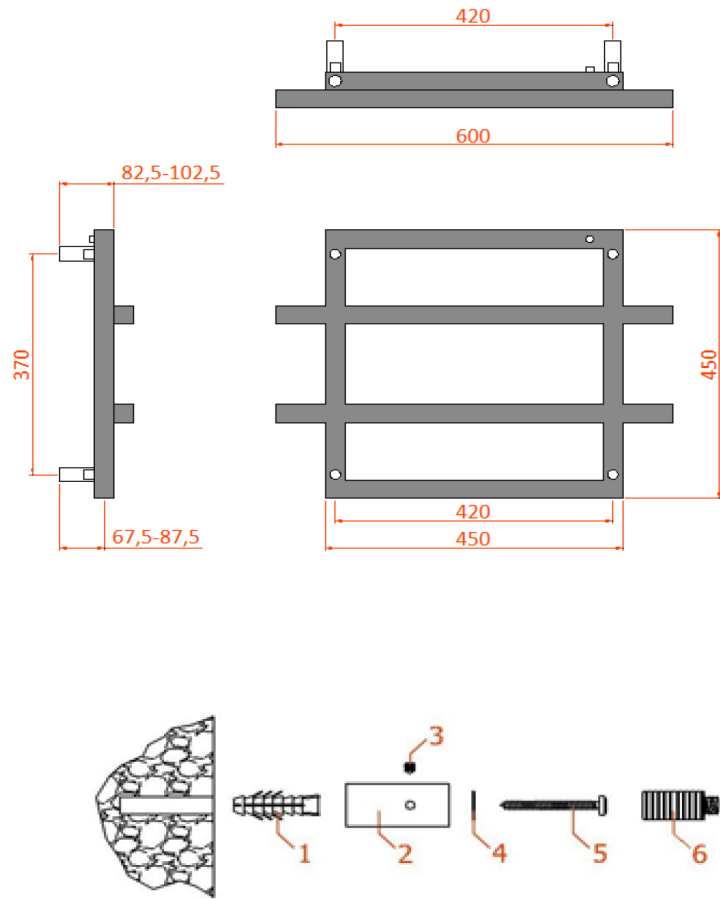

- A** The radiator should not be mounted closer than 50mm below any overhanging surface (i.e. shelf) and no lower than 100mm from the floor. Transfer the bracket drill position measurements to the wall.
- B** Drill the wall and insert wall anchors (1) (or other suitable fixings).
- C** Put the brackets (2) on the wall and screw them to the wall anchors (1) with fixing screws (5) and washers (4).
- D** Screw the brackets (6) onto the nuts welded on the back of the radiator.
- E** Insert brackets (6) into the brackets (2) and tighten the security screws (3).

### GENERAL RECOMMENDATION

- Before fitting the radiator it is necessary to wash out the heating system to remove any existing mud, scale, work residues, traces of flux, oil, etc.
- When the system water pH is outside the 5,5-8,5 range and/or when the dissolved is above 0,1mg/litre, it is always needed to protect the heating system components (the radiator is one of these) with a proper chemical treatment compatible with all parts in contact with water (silicon rubber too).
- In order to fit the radiator to the wall, it is necessary to choose the proper fixings for the wall material.
- If the system water exceeds 50°C, please install a warning mark near the radiator to avoid any accidental scalding.
- Clean the radiator surface only with a soft cloth to avoid scratching the finish and do not use chemical agents during cleaning operations. It is prohibited to climb on the radiator.
- Maximum working temperature 95°C, maximum working pressure 4 bar.