

Sales Code: NCU842

Description: 450mm W/H Basin

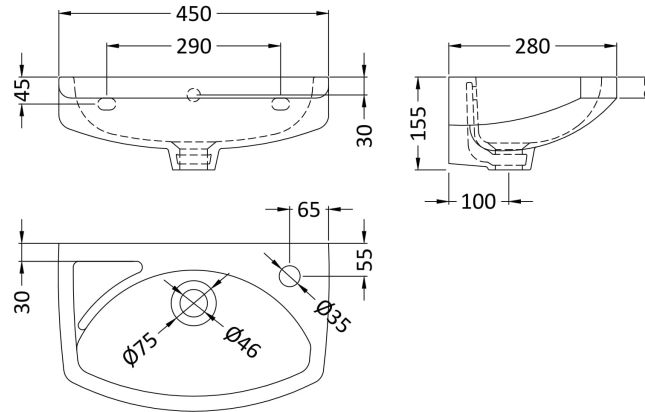

Product Dimensions

Height (mm):	0
Width (mm):	0
Depth (mm):	0
Nett Weight (kg):	8.3

Packaging Dimensions

Height (mm):	165
Width (mm):	460
Depth (mm):	300
Gross Weight (kg):	8.5

Packaging Data

Box Colour:	Brown Cardboard Box - Printed
Box Qty:	0
Label Size:	0 x 0
Label Colour:	White Label
Label Qty:	0

Outer Box Dimensions (If Applicable)

Height (mm):	
Width (mm):	
Depth (mm):	
Gross Weight (kg):	
Barcode:	5055369031047

Product Details

Country of Origin:	Turkey
Fitting Instruction:	No
Certification: CE & UKCA:	Yes WRAS: N/A WRAS No: N/A
Product Material:	Vitreous China
Fixing Supplied:	Yes

Pans/Bidets: Trap Style: Not Applicable Includes Seat: Not Applicable

Seats: Seat Type: Not Applicable Material: Not Applicable
Function: Not Applicable Hinge Type: Not Applicable
Hinge Material: Not Applicable

Cisterns: Operating Type: Not Applicable Fittings: Not Applicable
Lever Type: Not Applicable

Basins: Tap Hole: One Taphole Chain Stay Hole: No
Template: Not Required Waste Type Req: Slotted
Overflow Inc: Yes Overflow Cover: Yes
Inner Bowl Depth (mm): 110mm