

Sales Code: NCU862

Description: Corner W/H Basin

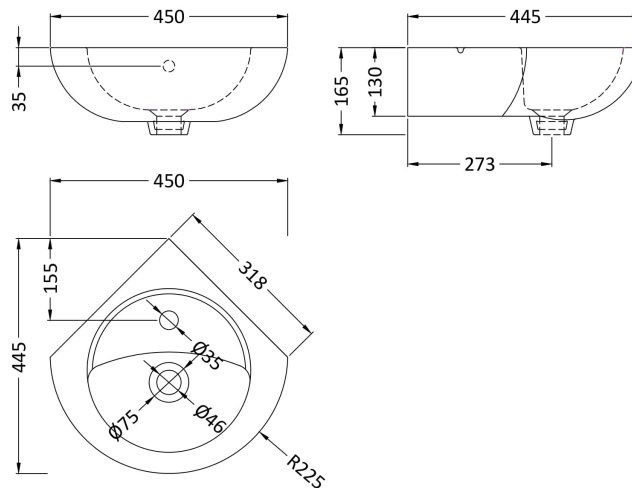

### Product Dimensions

Height (mm):	0
Width (mm):	0
Depth (mm):	0
Nett Weight (kg):	9.8

### Packaging Dimensions

Height (mm):	222
Width (mm):	390
Depth (mm):	390
Gross Weight (kg):	10

### Packaging Data

Box Colour:	Brown Cardboard Box - Printed
Box Qty:	0
Label Size:	0 x 0
Label Colour:	White Label
Label Qty:	0

### Outer Box Dimensions (If Applicable)

Height (mm):	
Width (mm):	
Depth (mm):	
Gross Weight (kg):	
Barcode:	5055369031054

### Product Details

Country of Origin:	Turkey
Fitting Instruction:	No
Certification: CE & UKCA: No	WRAS: N/A WRAS No: N/A
Product Material:	Vitreous China
Fixing Supplied:	Yes

**Pans/Bidets:** Trap Style: Not Applicable Includes Seat: Not Applicable

**Seats:** Seat Type: Not Applicable Material: Not Applicable  
Function: Not Applicable Hinge Type: Not Applicable  
Hinge Material: Not Applicable

**Cisterns:** Operating Type: Not Applicable Fittings: Not Applicable  
Lever Type: Not Applicable

**Basins:** Tap Hole: One Taphole Chain Stay Hole: No  
Template: Not Required Waste Type Req: Slotted  
Overflow Inc: Yes Overflow Cover: Yes  
Inner Bowl Depth (mm): 115mm