

Sales Code: NLT91064

Description: Rectangular Shower Tray 1700X900

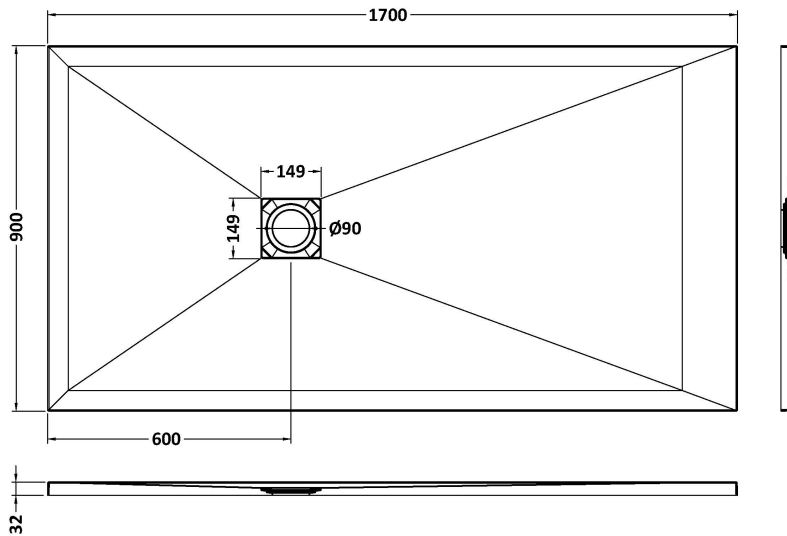

### Product Dimensions

Length (mm):	0
Width (mm):	0
Height (mm):	0
Nett Weight (kg):	66.3

### Packaging Dimensions

Length (mm):	1740
Width (mm):	940
Height (mm):	73
Gross Weight (kg):	66.3

### Packaging Data

Box Colour:	Shrinkwrap & Polystyrene
Box Qty:	0
Label Size:	0 x 0
Label Colour:	White Label
Label Qty:	0

### Outer Box Dimensions (If Applicable)

Length (mm):	
Width (mm):	
Height (mm):	
Gross Weight (kg):	
Barcode:	5056462656465

### Product Details

Country of Origin:	United Kingdom
Fitting Instruction:	Yes
CE & UKCA:	Yes
Colour/Finish:	Slate Black
Product Material:	Acrylic Capped ABS Caco3 & Pu
Material Colour Reference:	Slate Black
Radius:	0
Waste Required (mm):	0
Compatible with Leg Kit:	No