

Sales Code: WIN381

Description: Windon W/M 2Th Basin Mixer

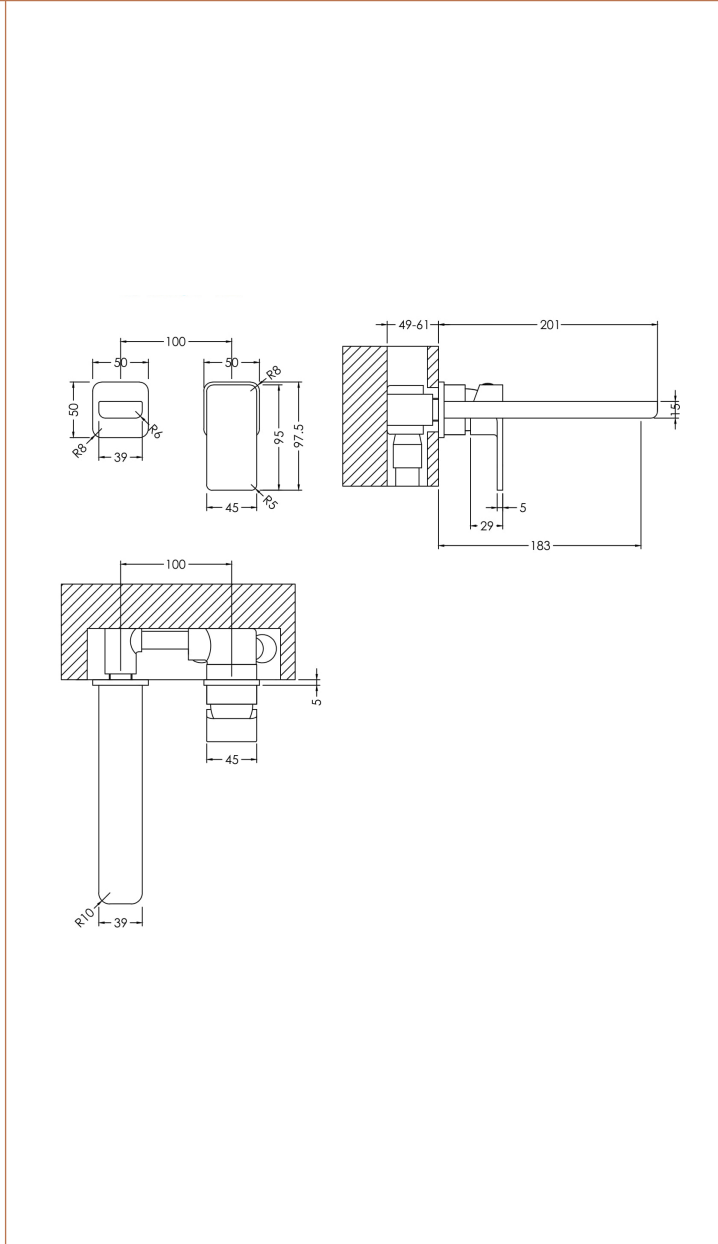

Product Dimensions

Height (mm):	50
Width (mm):	150
Depth (mm):	201
Length (mm):	
Nett Weight (kg):	1.93

Packaging Dimensions

Height (mm):	115
Width (mm):	205
Depth (mm):	250
Gross Weight (kg):	1.93

Packaging Data

Box Colour:	White Cardboard Box
Box Qty:	0
Label Size:	0 x 0
Label Colour:	White Label
Label Qty:	0

Outer Box Dimensions (If Applicable)

Height (mm):	600
Width (mm):	435
Depth (mm):	265
Length (mm):	
Gross Weight (kg):	
Barcode:	5056211898221

Product Details

Country of Origin:	China
Fitting Instruction:	Yes
Product Material:	Brass
Control Type:	Manual
Waste Included:	Waste Not Included
Waste Type:	Not Applicable
WRAS Approval: No	Approval No: N/A
Valve/Cartridge Type:	Single Lever Cartridge
Colour/Finish:	Chrome
Mount Type:	Wall
Operating Pressure (bar):	0.2
Flow Rates: (Litres Per Min)	0.1 bar: 2.8 0.5 bar: 7.1 1 bar: 10.4 2 bar: 15 3 bar: 18.5
Pipe Size:	1/2"
Pipe Centres:	100