

Sales Code: TSI307

Description: Sinclair High Rise Mixer Without Waste

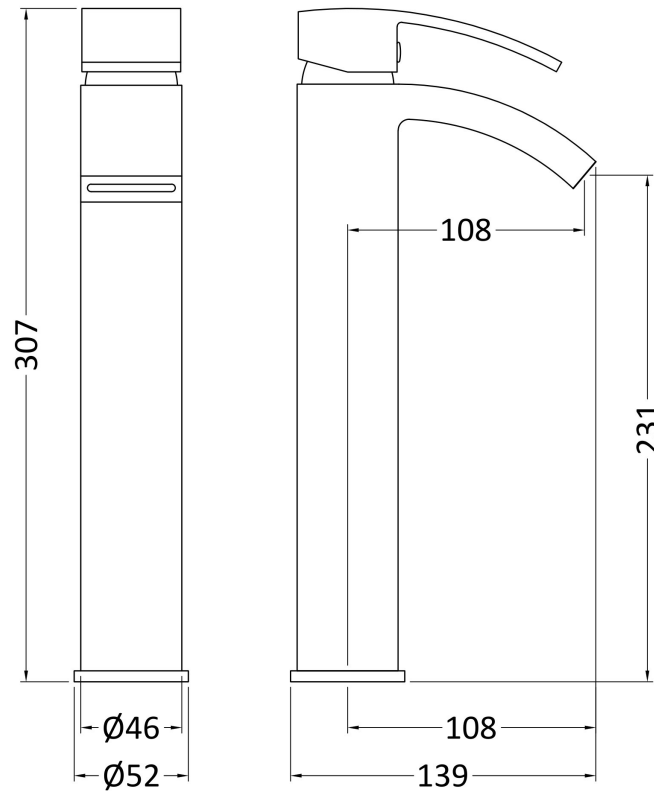

Product Dimensions

Height (mm):	318
Width (mm):	54
Depth (mm):	123
Length (mm):	
Nett Weight (kg):	1.9

Packaging Dimensions

Height (mm):	148
Width (mm):	54
Depth (mm):	318
Gross Weight (kg):	2.1

Packaging Data

Box Colour:	White Cardboard Box
Box Qty:	0
Label Size:	0 x 0
Label Colour:	White Label
Label Qty:	0

Outer Box Dimensions (If Applicable)

Height (mm):	350
Width (mm):	415
Depth (mm):	360
Length (mm):	
Gross Weight (kg):	22
Barcode:	5055369025565

Product Details

Country of Origin:	China
Fitting Instruction:	Yes
Product Material:	Brass
Control Type:	Manual
Waste Included:	Waste Not Included
Waste Type:	Not Applicable
WRAS Approval: No	Approval No: N/A
Valve/Cartridge Type:	Single Lever Cartridge
Colour/Finish:	Chrome
Mount Type:	Deck
Operating Pressure (bar):	0.2

Flow Rates: (Litres Per Min)	0.1 bar: N/A	0.5 bar: 8	1 bar: 12	2 bar: 17	3 bar: 21
Pipe Size:	15 mm (1/2" Bsp)				
Pipe Centres:	N/A				