

Sales Code: BIN317

Description: Binsey W/M 3Th Basin Mixer

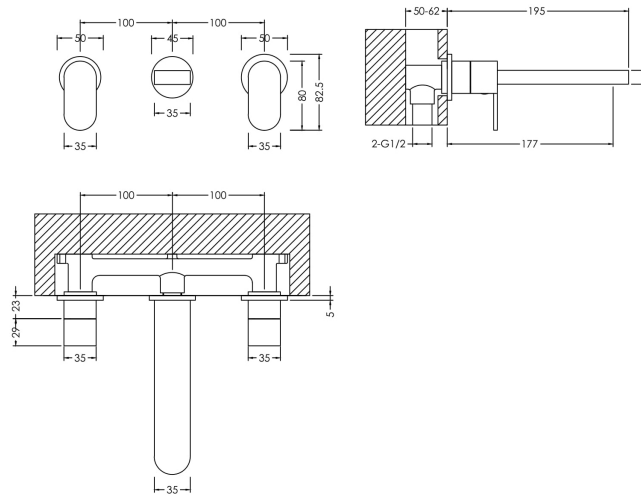

### Product Dimensions

Height (mm):	75
Width (mm):	245
Depth (mm):	195
Length (mm):	
Nett Weight (kg):	1.91

### Packaging Dimensions

Height (mm):	115
Width (mm):	185
Depth (mm):	325
Gross Weight (kg):	1.91

### Packaging Data

Box Colour:	White Cardboard Box
Box Qty:	0
Label Size:	0 x 0
Label Colour:	White Label
Label Qty:	0

### Outer Box Dimensions (If Applicable)

Height (mm):	600
Width (mm):	390
Depth (mm):	340
Length (mm):	
Gross Weight (kg):	
Barcode:	5056211898825

### Product Details

Country of Origin:	China
Fitting Instruction:	Yes
Product Material:	Brass
Control Type:	Manual
Waste Included:	Waste Not Included
Waste Type:	Not Applicable
WRAS Approval: No	Approval No: N/A
Valve/Cartridge Type:	1/4 Turn Ceramic Disc
Colour/Finish:	Chrome
Mount Type:	Wall
Operating Pressure (bar):	0.2
Flow Rates: (Litres Per Min)	0.1 bar: 3.4 0.5 bar: 8.7 1 bar: 12.6 2 bar: 18 3 bar: 20.8
Pipe Size:	1/2"
Pipe Centres:	100