

Sales Code: NVM003

Description: Minimalist Basin 600mm

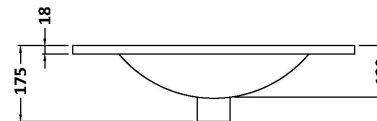
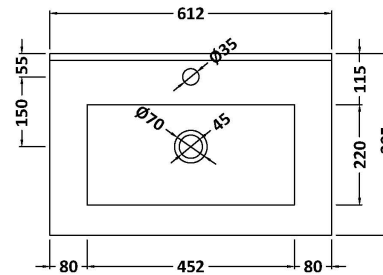
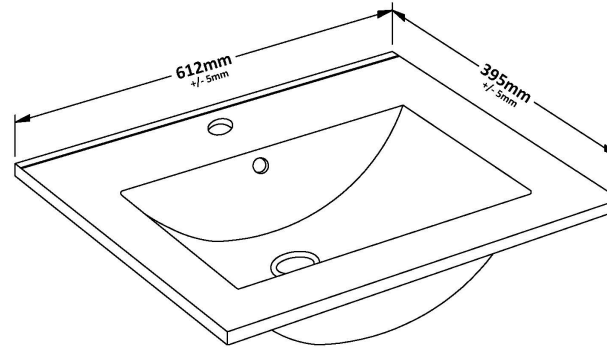

Product Dimensions

Height (mm):	0
Width (mm):	0
Depth (mm):	0
Nett Weight (kg):	10.76

Packaging Dimensions

Height (mm):	200
Width (mm):	400
Depth (mm):	620
Gross Weight (kg):	10.76

Packaging Data

Box Colour:	Brown Cardboard Box - Printed
Box Qty:	0
Label Size:	0 x 0
Label Colour:	White Label
Label Qty:	0

Outer Box Dimensions (If Applicable)

Height (mm):	
Width (mm):	
Depth (mm):	
Gross Weight (kg):	
Barcode:	5055146194668

Product Details

Country of Origin:	China
Fitting Instruction:	No
Certification: CE & UKCA:	No
WRAS:	N/A
WRAS No:	N/A
Product Material:	Vitreous China
Fixing Supplied:	No

Pans/Bidets: Trap Style: Not Applicable Includes Seat: Not Applicable

Seats: Seat Type: Not Applicable Material: Not Applicable
Function: Not Applicable Hinge Type: Not Applicable
Hinge Material: Not Applicable

Cisterns: Operating Type: Not Applicable Fittings: Not Applicable
Lever Type: Not Applicable

Basins: Tap Hole: One Taphole Chain Stay Hole: No
Template: Not Required Waste Type Req: Slotted
Overflow Inc: Yes Overflow Cover: Yes
Inner Bowl Depth (mm): 130mm