

# BRISTAN

## Artisan Thermostatic Bath Filler

### Installation Instructions & User Guide

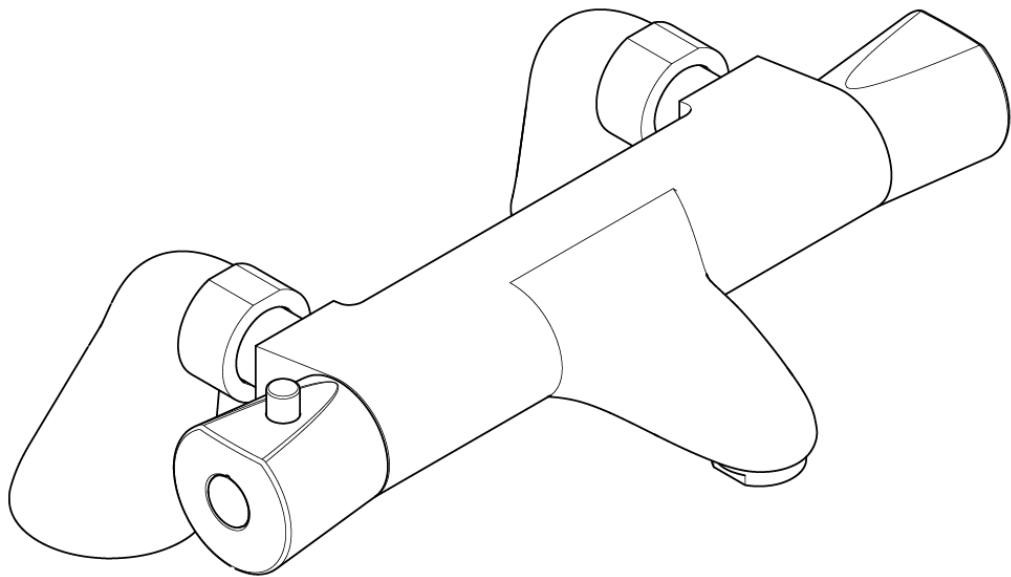

Please keep these instructions for future reference and request of replacement parts

## General Information

Thank you for choosing Bristan, the UK's leading taps and showers expert. We have designed this product with your enjoyment in mind. To ensure that it works to its full potential, it needs to be fitted correctly. These fitting instructions have been created to give you all of the information you need and, if you need any further help, please do not hesitate to give us a call on 0844 701 6273.

## Specifications

**Inlet Connections:** G3/4" Inlet Connections

**Operating Pressure Range:** Minimum. 0.2 bar, Maximum 5.0 bar.  
Maximum Static Pressure: 10.0bar.

Factory set temperature: 38°C (Can be re-set / overridden to suit site conditions).  
In order to comply with Part G regulations, the temperature can only be set to a maximum of 48°C.

### Supply Requirements:

Minimum cold water supply temperature: 5°C  
Maximum cold water supply temperature: 25°C  
Maximum hot water supply temperature: 80°C  
(a maximum hot water supply of 60-65°C is recommended for ablutionary purposes).

**Note:** The inlet hot water temperature must be at least 10°C above the required blend temperature (e.g. outlet temperature 43°C: Minimum hot supply 53°C).

Nominally equal (balanced) inlet supply pressures are recommended for optimum performance. If pressures are unequal, then a pressure reducing valve should be used.

This product has been designed and manufactured to the highest quality standards and is to be used within systems designed to BS 6700.

BS 6700 recommends the temperature of stored water should never exceed 65°C. A stored water temperature 60°C is considered sufficient to meet all nominal requirements and will minimise the build up of lime scale in hard water areas.

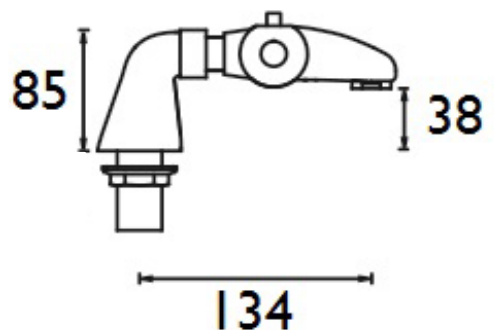
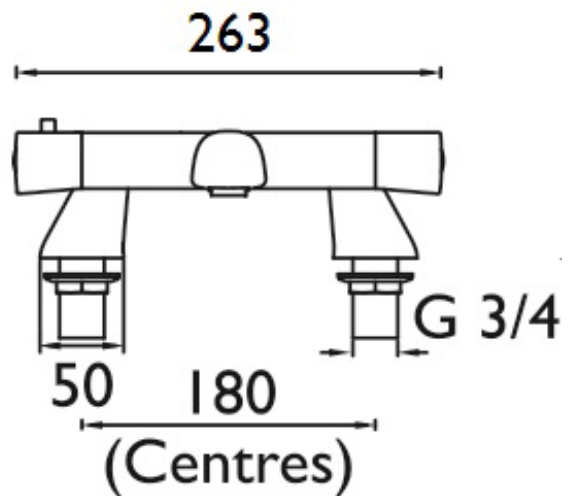

## Prior to Installation

Identify all components prior to starting installation.

- |                    |                      |
|--------------------|----------------------|
| 1. Mixer Body x1   | 4. Washers x2        |
| 2. Pillar Legs x2  | 5. Back Nuts x2      |
| 3. Base Washers x2 | 6. Filter Washers x2 |

This mixing valve should be installed in compliance with current water regulations. For further details contact your Local Water Authority.

This mixing valve is suitable for the following systems:

Gravity Fed Hot & Cold (Equal Pressures)

Unvented Systems

Gas Combination Boiler

Pumped System (Equal Pressures)

**Note:** On gravity systems the minimum distance from the underside of the water tank / cylinder to the mixing valve must be at least 2 metres.

Before connecting the mixing valve, thoroughly flush through the water supply pipes to remove any remaining swarf, debris. Failure to do so may result in damaging the product.

## Installation – See illustration below

1. Place filter washers into the pillars and screw the pillar legs onto the mixer body.
2. Place the mixer body onto the bath ensuring the base washers are fitted to the threaded legs of the pillars.

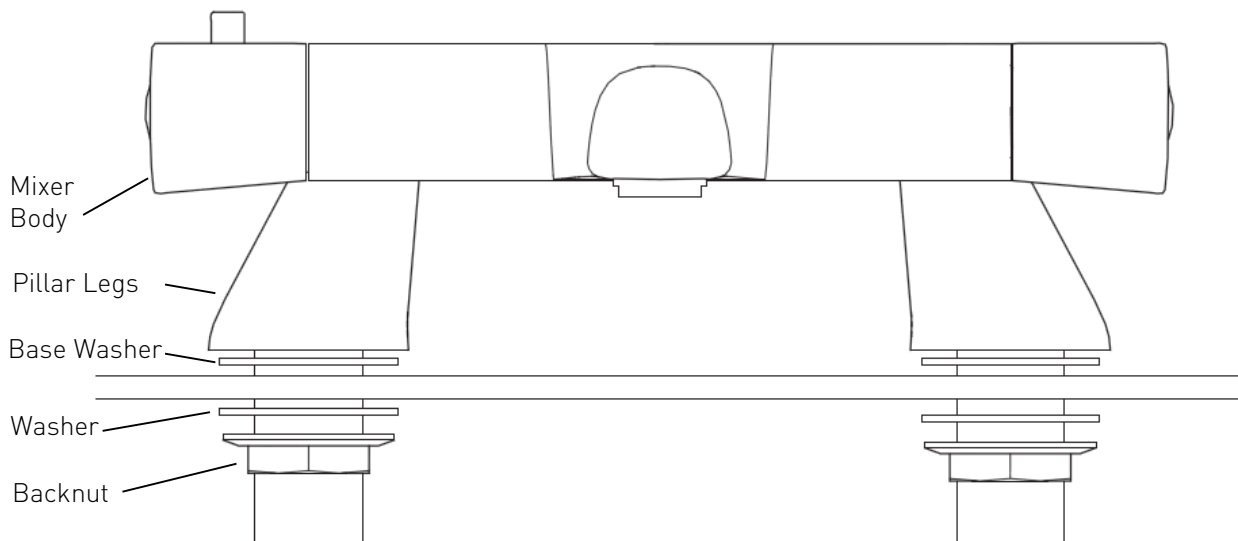

3. Push the washers onto the threaded pillar legs and screw the backnuts onto the threaded pillar legs and tighten fully against the underside of the bath.
4. Connect the hot and cold water supplies to the pillar legs ensuring the hot supply on the left and the cold supply on the right (when viewed from the front).
5. Turn on both water supplies letting the water run at both hot and cold settings for a few minutes to check all joints and connections for any leaks.

**Important:** Access must be made available to the water supplies and fixings for future maintenance / servicing.

## Temperature Setting – See Illustration below

The temperature is factory set at 38°C, however this may be overridden by simply pressing the temperature override button in when the handle reaches the stop and continuing to turn the handle.

To reset the maximum temperature the following should be carried out.

1. Remove the end cap (1).
2. Unscrew the handle screw (2).
3. Remove the handle (3).
4. Turn the valve spindle (4) in the Required direction.

To increase the temperature  
turn the spindle anti-clockwise

To decrease the temperature  
turn the spindle clockwise.

5. Replace the handle (3), tighten the screw (2) and push fit the cap (1) back into position.

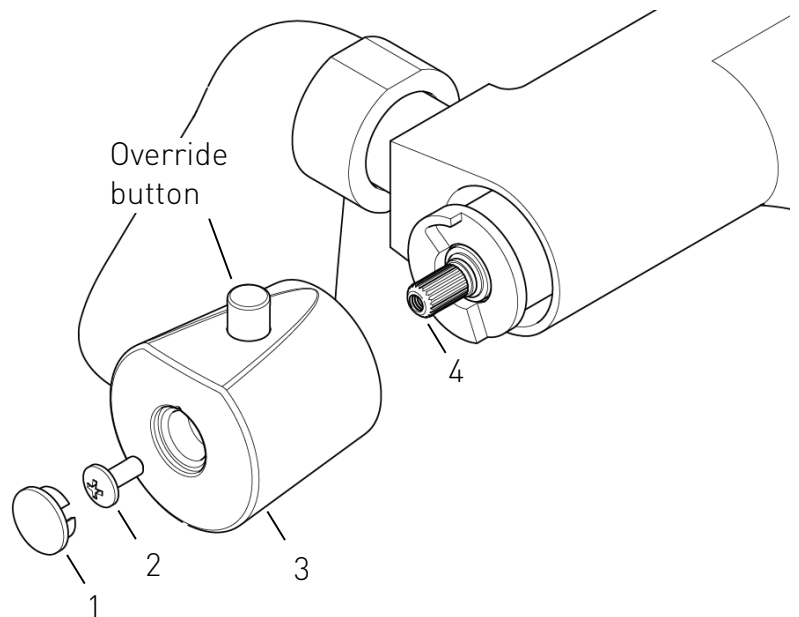

## General Cleaning

Your fitting has a high quality finish and should be treated with care to preserve the visible surfaces. All finishes will wear if not cleaned correctly. The only safe way to clean your product is to wipe with a soft damp cloth. Stains can be removed using washing up liquid. All bathroom cleaning products (powders and liquids) will damage the surface of your fitting, even the non-scratch cleaners.

Note: Never use abrasive detergents or disinfectants or those containing alcohol, hydrochloric or phosphoric acid.

## Maintenance

We advise that your product is regularly serviced, particularly in hard water areas to reduce the build up of lime scale and to ensure your product performs to its full potential.

To service the mixing valve the following should be carried out.

### Flow Valve servicing / replacement

Turn off both the hot and cold water supplies to the mixing valve and close any stop / service valves.

Remove the cap (1) and loosen the screw (2).

Pull the handle (3) off from the valve spindle.

Unscrew the valve (4) and clean / replace with a new valve supplied by Bristan.

Re-fit valve (4) and push the handle (3) onto the valve spindle.

Tighten the screw (2) and push-fit the cap (1) into position.

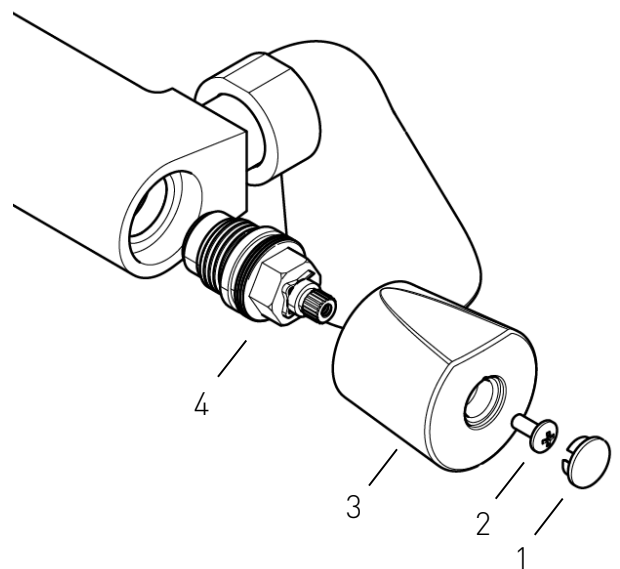

## Flow Valve servicing / replacement

Turn off both the hot and cold water supplies to the mixing valve and close any stop / service valves.

Remove the cap (1) and loosen the screw (2).

Pull the handle (3) off from the valve spindle.

Remove the temperature stop (4), remembering the position when removed.

Unscrew the cartridge (5) and clean / replace with a new valve supplied by Bristan.

Re-fit cartridge (5) and temperature stop (4) in the same position when removed.

push the handle (3) onto the valve spindle.

Tighten the screw (2) and push-fit the cap (1) into position.

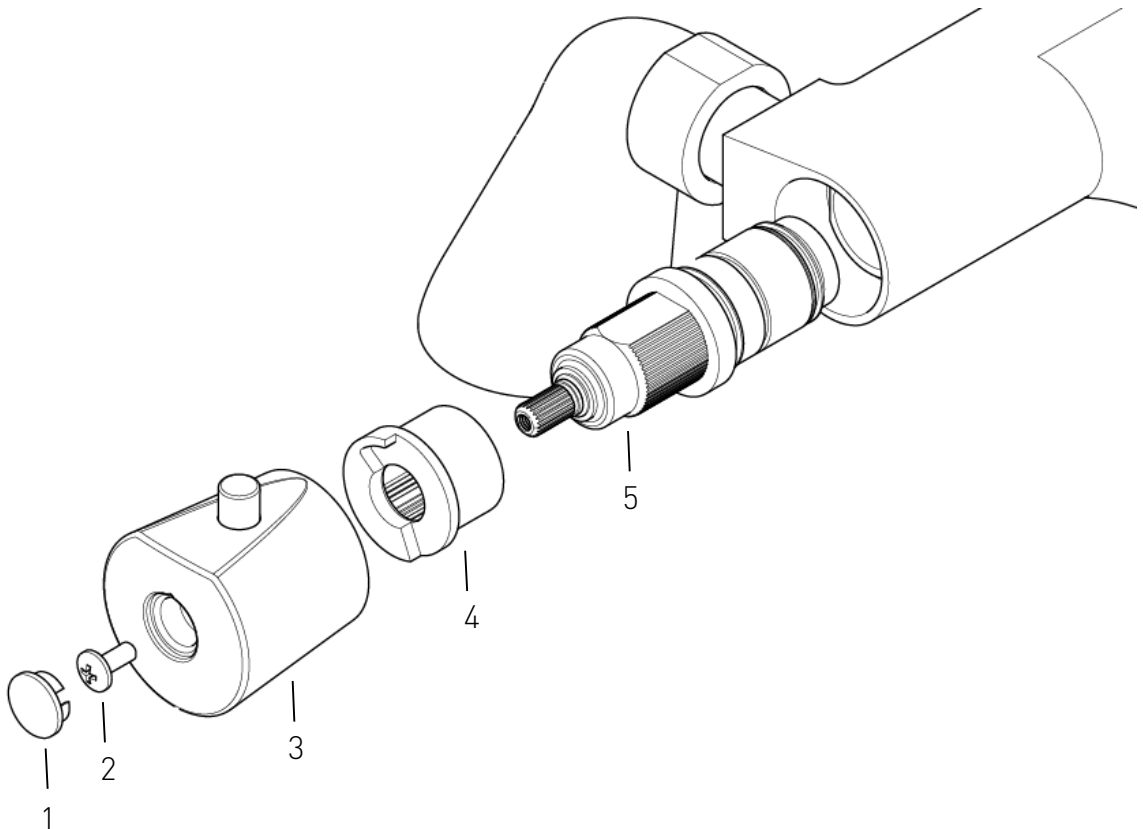

## Troubleshooting

Symptom	Cause	Remedy
Maximum water temperature too hot or cold.	Maximum water temperature set incorrectly.	Reset maximum water temperature. Refer to 'Commissioning' section.
Outlet water temperature too hot / cold.	Inlet filter is partially blocked.	Check inlet filters for any blockages and clean as necessary.
	Installation conditions outside operating parameters.	Service shower valve as recommended. Refer to maintenance section.
Water temperature too cold – maximum water temperature incorrectly set.	Hot water temperature is less than 10°C above the required blend temperature.	Adjust hot water temperature or wait for water to reheat if stored system is used.
	Instantaneous water heater not igniting because water flow rate is too low.	Increase water flow rate through the system.  Check cartridge inlet filters and clean or replace. Refer to maintenance section.  Contact the boiler manufacturer.
	Instantaneous water heater not igniting because water pressure is too low.	Refer to 'Specification' for system requirements.  Increase water pressure through system.  Contact the boiler manufacturer.
Only hot or cold water from TMV outlet.	Inlet water supplies are reversed (hot to cold supply).	Check the connections are the correct way round. Hot on the left and cold on the right when viewed from the front. Rework pipework as necessary.
	Inlet filter is partially blocked.	Clean or replace, flush through pipework before refitting.

## Troubleshooting

Symptom	Cause	Remedy
No flow or low flow rate and / or varying temperatures.	Partially closed stop or service valve in water supply pipework to the mixer valve.	Open stop or service valve.
	Instantaneous water heater cycles on and off as the flow rate or pressure is too low.	Increase water flow rate or pressure through system  Contact the boiler manufacturer.
	Head of water is below the minimum distance required.	Refer to the 'Specification' section.
	Inlet filter is partially blocked.	Clean or replace, flush through pipework before refitting.
	Hot or cold water being drawn off elsewhere causing pressure changes or instantaneous boiler changes.	Do not use other water outlets when using the shower valve.
	Make sure the maintained inlet pressures are nominally balanced and sufficient.	If pressures are unbalanced then a pressure reducing valve should be used.
	Airlock or partial blockage of the pipework.	Flush through pipework to ensure removal of debris and any airlocks.
	No hot or cold water reaching the shower valve.	Check hot and cold feeds (the valve will shut down if either the hot or cold supply fails).



## Notes

Please use this space to add any notes you or your installer may have regarding the plumbing system / installation of this product.

## Notes

Please use this space to add any notes you or your installer may have regarding the plumbing system / installation of this product.

# Bristan Guarantee

# BRISTAN

Bristan offers solid guarantees to provide you with complete peace of mind.

## Taps and Mixers

5 year parts and 1 year labour\*. Gold, painted and special finishes 3 years parts only.

All subject to proof of purchase.

## Mixer Shower Valves

5 year parts. 5 year labour\* (subject to registration), or 1 year with proof of purchase.

Gold, painted and special finishes 3 years parts only.

## Pumps and Power Showers

2 year parts. 1 year labour\* (subject to registration).

## Electric Showers/Instantaneous Water Heaters

2 year parts. 1 year labour\* (subject to registration).

## Accessories

5 year parts only. Includes bathrooms accessories, shower accessories (e.g. hoses, handsets and poles), wastes, WC levers and light pulls. Gold, painted and special finishes 3 years parts only.

## Sanitaryware

5 year parts only. Subject to proof of purchase.

## Shower Enclosures and Shower Trays

10 year parts (subject to registration), or 2 years with proof of purchase. 1 year labour\* (subject to registration), or 1 year with proof of purchase.

## Heated Towel Rails

5 year parts only. Gold, painted and special finishes 3 years parts only. All subject to proof of purchase.

\*Labour provided by an approved Bristan engineer. Guarantee only applies to products with a manufacturing fault. A deferred payment will be necessary in order to secure any visits by our engineers which will be charged if the problem is found **not** to be a manufacturing fault. If the fault is found to be down to a manufacturing error, the payment will be released and not charged.

This guarantee applies to products purchased within the United Kingdom or Republic of Ireland, but does not apply to products used commercially.

The guarantee is only available to original purchasers who have proof of purchase.

The installation must allow ready access to all products for the purpose of inspection, maintenance or replacement.

Any part found to be defective during the above guarantee period will be replaced without charge, providing that the product has been installed in accordance with the instructions, used as intended, and regularly serviced.

Servicing should be carried out at regular intervals of no more than 12 months and more frequently in hard water areas (heavy lime scale) areas.

In the unlikely event that any problems are encountered with the product's performance on installation, you must obtain guidance/authorisation from our Customer Service Department, and be able to supply proof and date of purchase, before any remedial action is taken.

The guarantee excludes general wear and tear and damage caused by accident, misuse or neglect, and does not cover the following:

- Components that are subject to general wear and tear such as filters, seals, 'O' rings and washers etc.
- Damage caused by faulty installation
- Damage caused by lime scale or any waterborne debris
- Damage caused by inappropriate cleaning products (see user instructions)
- Damage caused by the use of non-Bristan parts
- The product being used for a purpose other than intended by the manufacturer.

In the interests of continuous product improvement Bristan reserves the right to alter specification as necessary.

If your product is out of its guarantee period, or you would like to extend the guarantee, then please see our [extended warranty offer](#).



**Guarantee**



**Guarantee**



**Guarantee**



**Guarantee**



**Guarantee**

# BRISTAN

This booklet covers product codes

AR2 THBF C

Helpline

0844 701 6273

Bristan Group Limited

Birch Coppice Business Park, Dordon, Tamworth, Staffordshire B78 1SG

A Masco Company

Website: [www.bristan.com](http://www.bristan.com)

Telephone: 0844 7016 274      Facsimile: 0844 701 6275

Email: [enquire@bristan.com](mailto:enquire@bristan.com)