

Sales Code: NBC005

Description: Classic 850mm 1T/H Basin

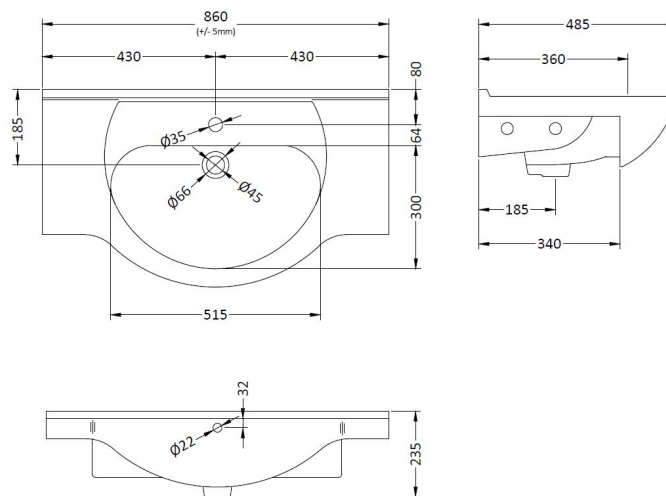

### Product Dimensions

Height (mm):	485
Width (mm):	855
Depth (mm):	235
Nett Weight (kg):	25

### Packaging Dimensions

Height (mm):	530
Width (mm):	875
Depth (mm):	235
Gross Weight (kg):	25.87

### Packaging Data

Box Colour:	Brown Cardboard Box - Printed
Box Qty:	1
Label Size:	100 x 50
Label Colour:	Not Applicable
Label Qty:	0

### Outer Box Dimensions (If Applicable)

Height (mm):	
Width (mm):	
Depth (mm):	
Gross Weight (kg):	
Barcode:	5055146172918

### Product Details

Country of Origin:	China
Fitting Instruction:	No
Certification: CE & UKCA:	No
WRAS:	N/A
WRAS No:	N/A
Product Material:	Vitreous China
Fixing Supplied:	No

**Pans/Bidets:** Trap Style: Not Applicable Includes Seat: Not Applicable

**Seats:** Seat Type: Not Applicable Material: Not Applicable  
Function: Not Applicable Hinge Type: Not Applicable  
Hinge Material: Not Applicable

**Cisterns:** Operating Type: Not Applicable Fittings: Not Applicable  
Lever Type: Not Applicable

**Basins:** Tap Hole: One Taphole Chain Stay Hole: No  
Template: Not Required Waste Type Req: Slotted  
Overflow Inc: Yes Overflow Cover: Yes  
Inner Bowl Depth (mm): 145mm