

Sales Code: NBC103

Description: 650 Deluxe Basin 1Th (300 Deep)

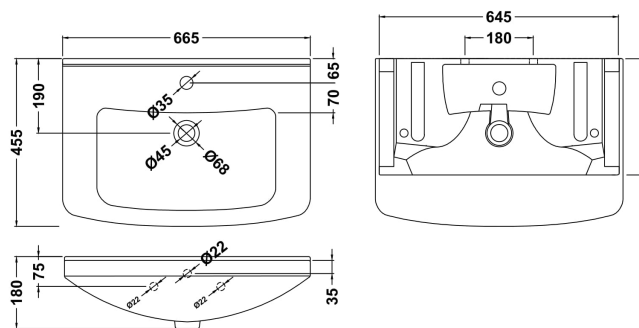

Product Dimensions

Height (mm):	180
Width (mm):	650
Depth (mm):	450
Nett Weight (kg):	17.5

Packaging Dimensions

Height (mm):	490
Width (mm):	190
Depth (mm):	690
Gross Weight (kg):	17.5

Packaging Data

Box Colour:	Brown Cardboard Box - Printed
Box Qty:	1
Label Size:	100 x 50
Label Colour:	Not Applicable
Label Qty:	0

Outer Box Dimensions (If Applicable)

Height (mm):	
Width (mm):	
Depth (mm):	
Gross Weight (kg):	
Barcode:	5055369054190

Product Details

Country of Origin:	China
Fitting Instruction:	No
Certification: CE & UKCA:	No
WRAS:	N/A
WRAS No:	N/A
Product Material:	Vitreous China
Fixing Supplied:	No

Pans/Bidets: Trap Style: Not Applicable Includes Seat: Not Applicable

Seats: Seat Type: Not Applicable Material: Not Applicable
Function: Not Applicable Hinge Type: Not Applicable
Hinge Material: Not Applicable

Cisterns: Operating Type: Not Applicable Fittings: Not Applicable
Lever Type: Not Applicable

Basins: Tap Hole: One Taphole Chain Stay Hole: No
Template: Not Required Waste Type Req: Slotted
Overflow Inc: Yes Overflow Cover: Yes
Inner Bowl Depth (mm): 115mm