

Sales Code: CLA141

Description: 500 Wc Unit (818X500x253)

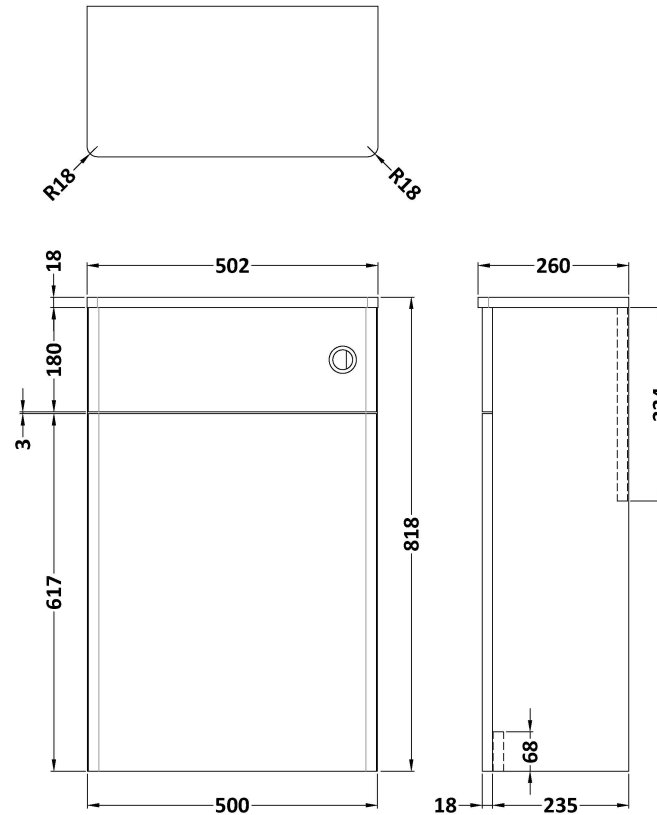

Product Dimensions

Height (mm):	818
Width (mm):	500
Depth (mm):	253
Nett Weight (kg):	15.9

Packaging Dimensions

Height (mm):	860
Width (mm):	525
Depth (mm):	285
Gross Weight (kg):	16.4

Packaging Data

Box Colour:	Brown Cardboard Box
Box Qty:	1
Label Size:	100 x 50
Label Colour:	White Label
Label Qty:	2

Outer Box Dimensions (If Applicable)

Height (mm):	
Width (mm):	
Depth (mm):	
Gross Weight (kg):	
Barcode:	5056462643342

Product Details

Country of Origin:	China
Fitting Instruction:	No
CE & UKCA:	N/A
FSC Certified Materials:	Yes
Colour:	Satin Anthracite
Construction Method:	Cam & Wood Dowel
Construction Type:	Rigid
Cabinet Finish:	MFC Painted Matt
Fascia Finish:	Mdf Painted Matt
Cabinet Thickness (mm):	18
Fascia Thickness (mm):	18
Drawer Included:	No
Drawer Type:	Not Applicable
No of Shelves:	Not Applicable
Hinge Type:	Not Applicable
Hinge Included:	Not Applicable
Adjustable Legs:	No, Not Required
Fixings Included:	Yes
Handle Style:	Not Applicable
Waste Shroud:	Not Applicable
Handle Included:	Not Applicable
Handle Type:	Not Applicable