

Sales Code: HLW55D

Description: Sloane Horizontal Double Panel 600X586

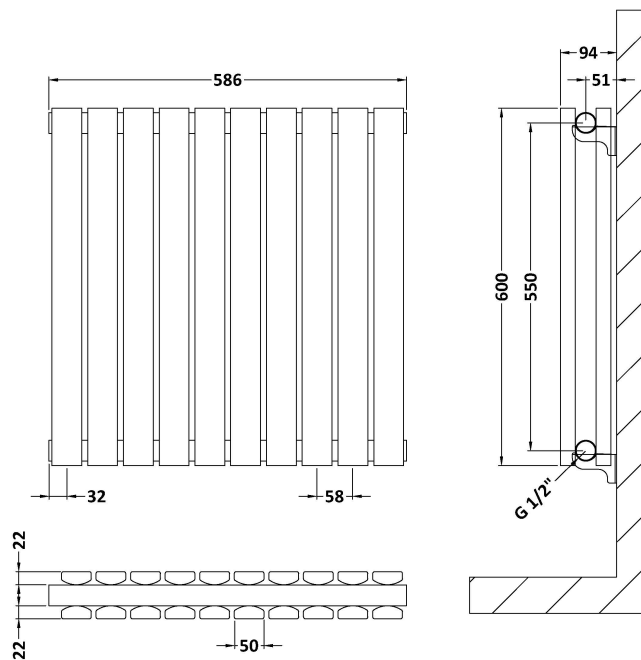

Product Dimensions

Height (mm):	600
Width (mm):	586
Depth (mm):	72
Length (mm):	
Nett Weight (kg):	19.5

Packaging Dimensions

Height (mm):	660
Width (mm):	650
Length (mm):	105
Gross Weight (kg):	20

Packaging Data

Box Colour:	White Cardboard Shrinkwrapped
Box Qty:	1
Label Size:	100 x 50
Label Colour:	White Label
Label Qty:	2

Outer Box Dimensions (If Applicable)

Height (mm):	
Width (mm):	
Length (mm):	
Gross Weight (kg):	
Barcode:	5056211885436

Product Details

Country of Origin:	China		
Fitting Instruction:	No		
Certification:	CE & UKCA: Yes	RoHS: N/A	WEEE: N/A
Colour/Finish:	Satin White		
RAL No:	9003		
Product Material:	Steel		
Heat Element Wattage:	Not Applicable		
Heating Element Wattage Compatible:	N/A		
BTU Outputs:	30°C / 965	50°C / 1863	60°C / 2360
Thermal Outputs: (Watts)	30°C / 283	50°C / 546	60°C / 692
Pipe Centres - If Vertical:			
Pipe Centres - If Horizontal:	676		
Max Projection:	110mm		
Tube Diameter:			
Packaging Volume (L):			
Wall to Centre of Tappings:	N/A		
Floor to Centre of Tappings:	51		
Dual Fuel:	N/A		
IP Rating:			