

Sales Code: NVC180A

Description: 2 Door Corner Unit And Basin

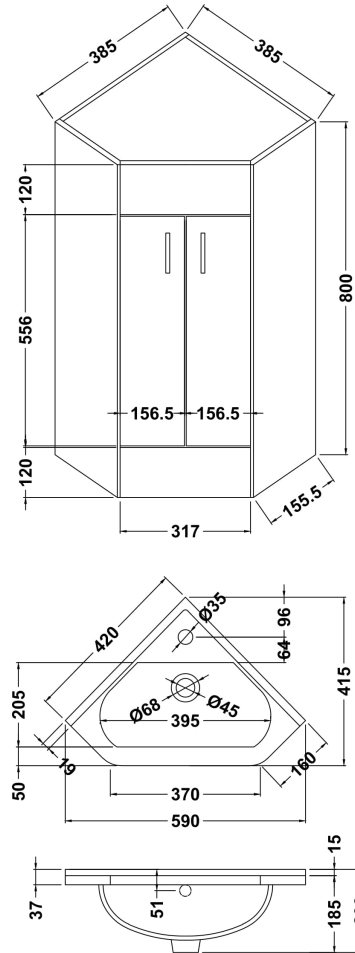

Product Dimensions

Height (mm):	800
Width (mm):	385
Depth (mm):	385
Nett Weight (kg):	23.3

Packaging Dimensions

Height (mm):	840
Width (mm):	410
Depth (mm):	410
Gross Weight (kg):	24.3

Packaging Data

Box Colour:	Brown Cardboard Box - Printed
Box Qty:	1
Label Size:	100 x 50
Label Colour:	Not Applicable
Label Qty:	0

Outer Box Dimensions (If Applicable)

Height (mm):	
Width (mm):	
Depth (mm):	
Gross Weight (kg):	
Barcode:	5060272823320

Product Details

Country of Origin:	China
Fitting Instruction:	No
CE & UKCA:	No
FSC Certified Materials:	Not Applicable
Colour:	Gloss White
Construction Method:	Cam & Wood Dowel
Construction Type:	Rigid
Cabinet Finish:	MFC Painted Gloss
Fascia Finish:	Mdf Painted Gloss
Cabinet Thickness (mm):	16
Fascia Thickness (mm):	18
Drawer Included:	No
Drawer Type:	Not Applicable
No of Shelves:	1
Hinge Type:	95 Deg Inset Clip-On Non S/C
Hinge Included:	Yes
Adjustable Legs:	No
Fixings Included:	Yes
Handle Style:	Modern
Waste Shroud:	No
Handle Included:	Yes
Handle Type:	D-Shape