

## Thermostatic Shower Kit Installation Instruction

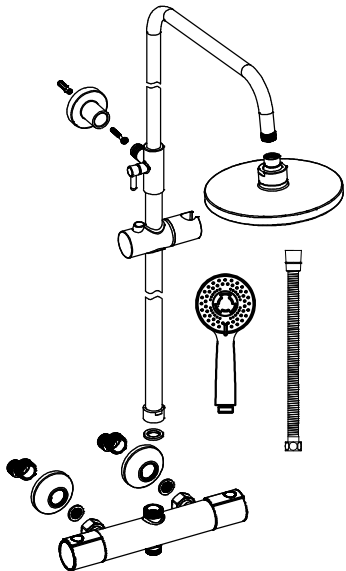

Step 1: Disassemble all the parts according to the figure above.

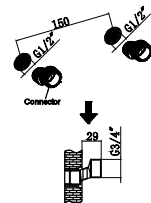

Step 2: Apply suitable thread sealant (not supplied) and attach the offset connectors to the pipework in the wall, making center distance of 150mm, 28mm from the wall.

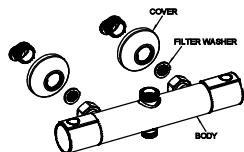

Step 3: Attach the covers against wall, place filters into the inlets. Then fix mixer onto the wall with spanner, checking for leakage.

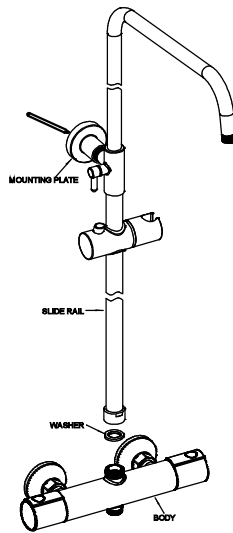

Step 4: Apply washer into the bottom of sliding rail, then fix the sliding rail onto the mixer body. Make markings for the position of the mounting plate, then take off the sliding rail.



Step 5: Place mounting plate against wall and make markings for a hole. Drill a hole of 25mm with depth of 45mm. Tap in wall plugs, then fix the mounting plate against wall with screws.

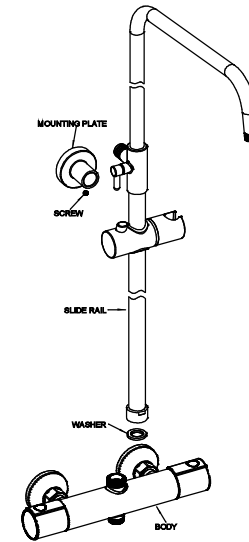

Step 6: Apply washer into the bottom of sliding rail then fix the sliding rail onto the mixer body. Then fix sliding rail onto mounting plate, tighten with screws.

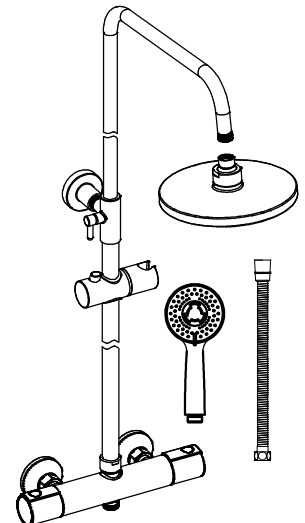

Step 7: Finally connect shower hose, handshower and headshower to the shower mixer.